

THE X-BEAM AS A DEPLOYABLE BOOM FOR THE SPACE STATION

Louis R. Adams*

ABSTRACT

Extension of antennas and thrust modules from the primary structure of the Space Station will require deployable booms of high stiffness and strength, as well as low mass and package volume. A square boom cross-section is desirable for interface reasons. These requirements and others are satisfied by the X-Beam.

The X-Beam folds by simple geometry, using single-degree-of-freedom hinges at simple angles, with no strain during deployment. Strut members are of large diameter with unidirectional graphite fibers for maximum beam performance. Fittings are aluminum with phosphor-bronze bushings so that compliance is low and joint lifetime is high.

The several beam types required for different applications on the Space Station will use the same basic design, with changes in strut cross-section where necessary. Deployment is by a BI-STEM which pushes the beam out; retraction is by cables which cause initial folding and pull the beam in.

INTRODUCTION

The problems of launching and assembling the Space Station demand minimum package size and weight with maximum stiffness and strength. The design is shown in Figure 1 and embodies the following features:

- The mast articulation is the X-Beam version (patent pending) of the Astromast, shown in Figures 2 and 3, which has the following advantages:
 - Zero strain in the members during deployment, allowing use of large strut cross sections and high modulus graphite fibers.
 - Simple hinge angles, minimizing tooling costs.
 - High torsional and bending beam stiffness during deployment.
 - Maximum mast performance for minimum weight is achieved by using primarily unidirectional graphite fibers for all loaded members.
 - Diagonal members perform as compression and tension members so that only one diagonal is required per face, minimizing mass and maximizing stiffness.

*Astro Aerospace Corporation, Carpinteria, California

- The mast hinges are single-degree-of-freedom journal bearings, with precise steel pins turning in lubricated phosphor bronze bushings to produce minimum freeplay hinges, ensuring linear performance of the deployed structure.
- Mast fittings will be made from aluminum alloy in order to minimize weight and price.
- Minimum deployer weight and package size are achieved by eliminating the conventional canister deployer or external framework mechanism. Instead, a BI-STEM, a proven space mechanism, is used to push the mast out while retraction is achieved by pulling in on four lanyards.

X-BEAM CONCEPT

The X-Beam, shown conceptually in Figure 2, packages in a unique way in that frames consisting of longerons and diagonals rotate together to the packaged configuration. These load-carrying members have hinges only at their ends. The only folding members are the battens at alternating bays, which in this structure are unloaded, serving only to stabilize the nodal points where struts meet. Because the diagonals cross each other when packaged, fittings are required near each diagonal midpoint, and the beam name is derived because of this configuration.

The hinges which allow this packaging are all parallel to the batten members associated with the frames, and are therefore at very simple angles. Because the frames do not change shape during deployment, no strain occurs. The folding battens have hinges which are parallel to the beam axis and may fold inwardly or outwardly.

DESIGN ISSUES

Significant issues, and features of the design which address them, are as follows:

High Boom Frequency

Ultra high modulus graphite/epoxy composite materials are used in the longerons, thereby maximizing stiffness and minimizing mass. Non-straining deployment allows this feature.

Low Boom Mass

All strut members are graphite/epoxy, thus minimizing mass. Fitting designs are conservative but determined largely by axial strut loading rather than bending, so that mass requirements are relatively low.

Thermal Distortion

Use of graphite/epoxy struts and aluminum fittings produces a structure which is highly stable thermally. The low temperature excursions expected permit this material combination.

Deployment Reliability

Deployment is sequential as the boom is extended by a sprocket-driven BI-STEM, which is a space-proven device, and each double-bay module is restrained by an escapement mechanism. The number of hinge joints in the structure is minimal, and the hinged batten has a moment-generating hinge which drives toward deployment.

Retraction Reliability

Retraction of the boom is accomplished by a simple system of tethers passed through pulleys in the beam. The load lines generated ensure that a single bay retracts when tension is applied to the tethers. The critical tension required to retract a bay is set by design of the folding batten.

DESIGN

Struts

Longerons are tubes and are hinged only at their ends. Diagonal struts are hinged at their ends and have central cross-over fittings for packaging. Batten A (rigid) struts are rigidly attached at structural nodes and are unhinged. Batten B (folding) struts are hinged at their ends and at their centers, so that they fold inward during packaging. Constant-moment torsion springs are incorporated in the Batten B center hinges to aid deployment.

Fittings

The various fittings, as machined for the prototype X-Beam, are shown in Figure 4. With the exception of the diagonal end fitting, all hinge axes are directed along major machining axes, so that no compound-angle machining is required. The hinge on the diagonal end fitting is oriented at a simple angle relative to the strut centerline. Hinges on all other end fittings are oriented orthogonally to the strut centerline. This simplicity of hinge angles is significant in minimizing complexity and cost of machining, and is also advantageous in terms of fitting stiffness. The proposed cluster fitting design at the rigid batten is shown in Figure 5.

The batten midhinge, shown in Figure 1, generates constant moment in the direction of full deployment. The torsion spring is rated at 3.6 Nm (32 in-lbf) and is of the negator type such that a short length of laminated spring is transferred from one spool to another. There are three major components: the spring and two joint bodies. The three hinges in the batten member (two

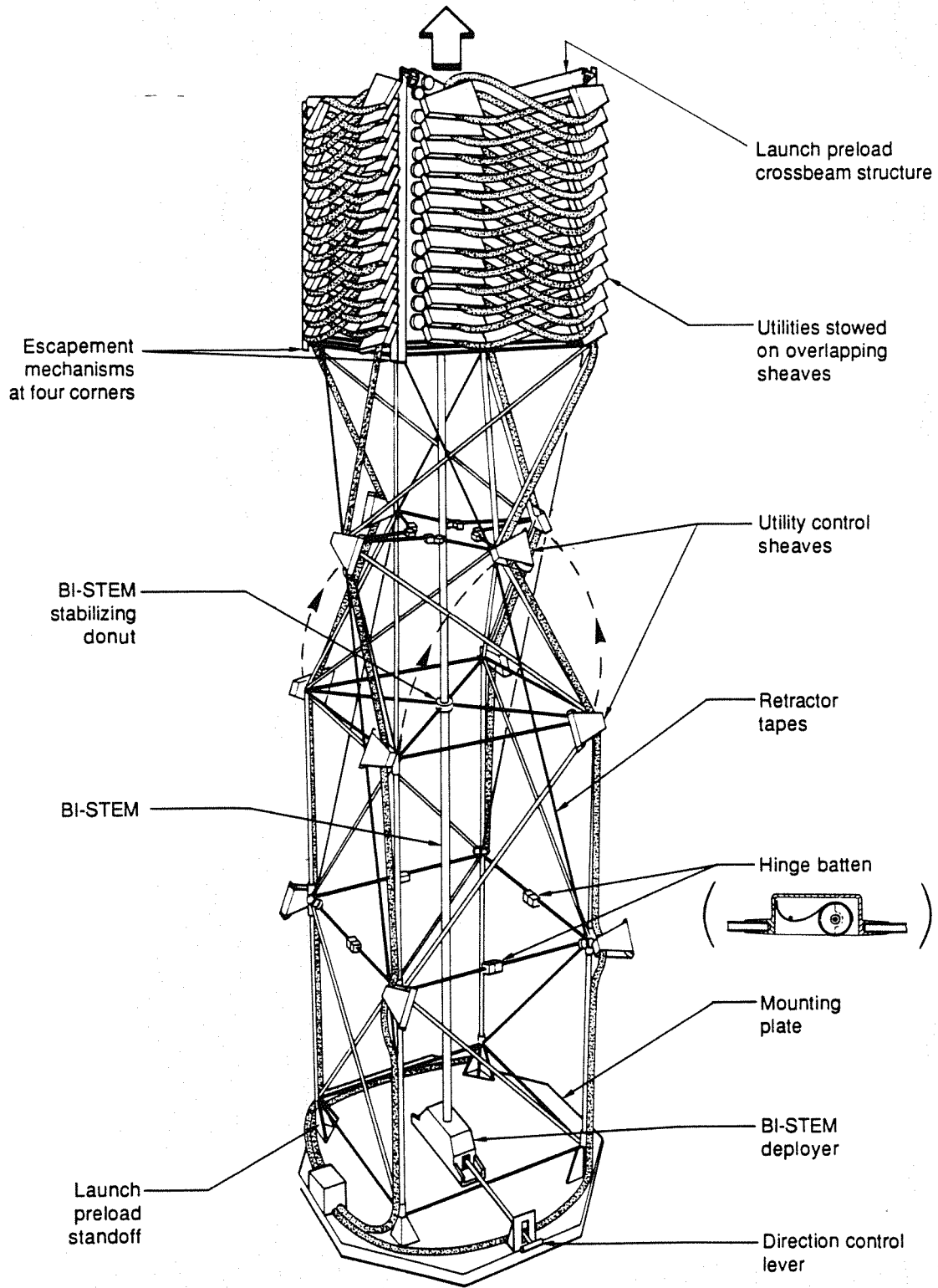

Figure 1. Space Station deployable boom.

ends and mid) are configured so that a compressive load on the batten strut generates a moment on the midhinge which is in the direction for folding. In this way, internal loading only is required for retraction; no mechanism is needed to fold the batten.

DEPLOYMENT

The method of deployment is shown in Figure 1. The stacked portion of the boom feeds out with the payload two bays at a time, pushed by the BI-STEM. The boom-to-Space Station interface stiffness is therefore not degraded during deployment. The outboard end of the boom, however, is degraded due to the two bays in transition. The stiffnesses of the BI-STEM and of four longerons in bending are sufficient to provide a minimum outboard natural frequency of about 4 hertz for the stacked starboard antenna boom with its 454-kilogram tip mass.

Axial deployment force (about 450 N) is provided by a sprocket-driven, tabbed, 35-millimeter-diameter BI-STEM which extends up the center of the boom. The positive nature of the sprocket drive ensures that the stated force level is achieved; periodic tabs along the internal element of the BI-STEM prevent rotation relative to the outer element, so that structural integrity is preserved. The BI-STEM is stabilized every two bays against lateral deflection by close-fitting rings suspended in the centers of the rigid batten frames. Sequential bay deployment is assured due to an escapement mechanism through which each batten frame must be pulled.

RETRACTION

In Figure 6, the method of retraction is shown. Beryllium copper ribbon cables, which are fed out with the beam during deployment, provide retraction forces in a sequential fashion due to the path they follow through the boom. The BI-STEM which deployed the beam is retracted in concert with the retracting boom. The mid-battens fold inward so that utility lines are not disturbed. The sequence of events, repeated until full retraction, are:

1. Mid-battens of double-bay module nearest stack are folded by internal loading (225 N tension required per ribbon cable).
2. Double-bay module and associated utilities retract.
3. Boom is pulled through escapement (23 N tension required per ribbon cable).
4. Packaged double-bay module seats on stack.

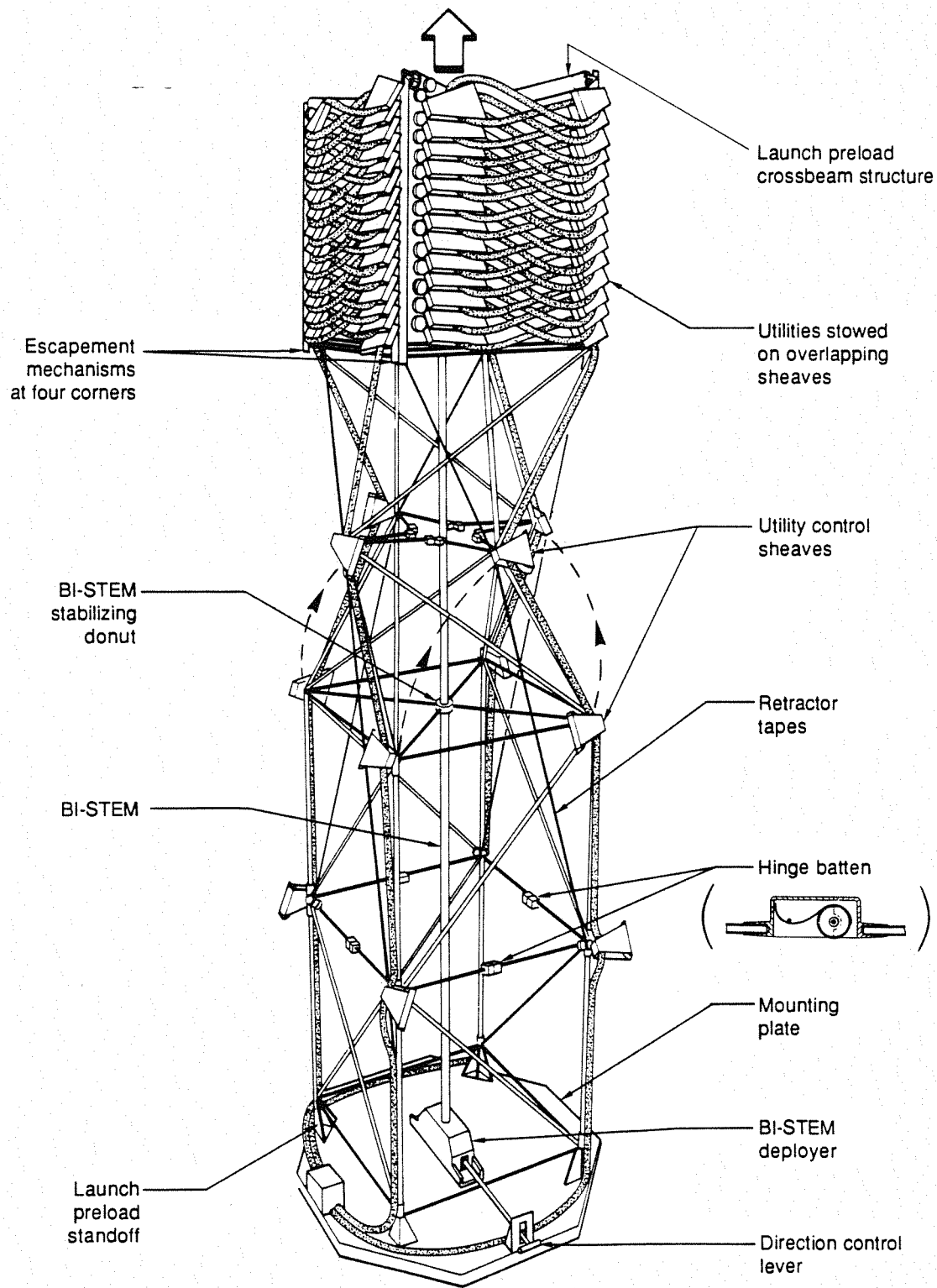

Figure 1. Space Station deployable boom.

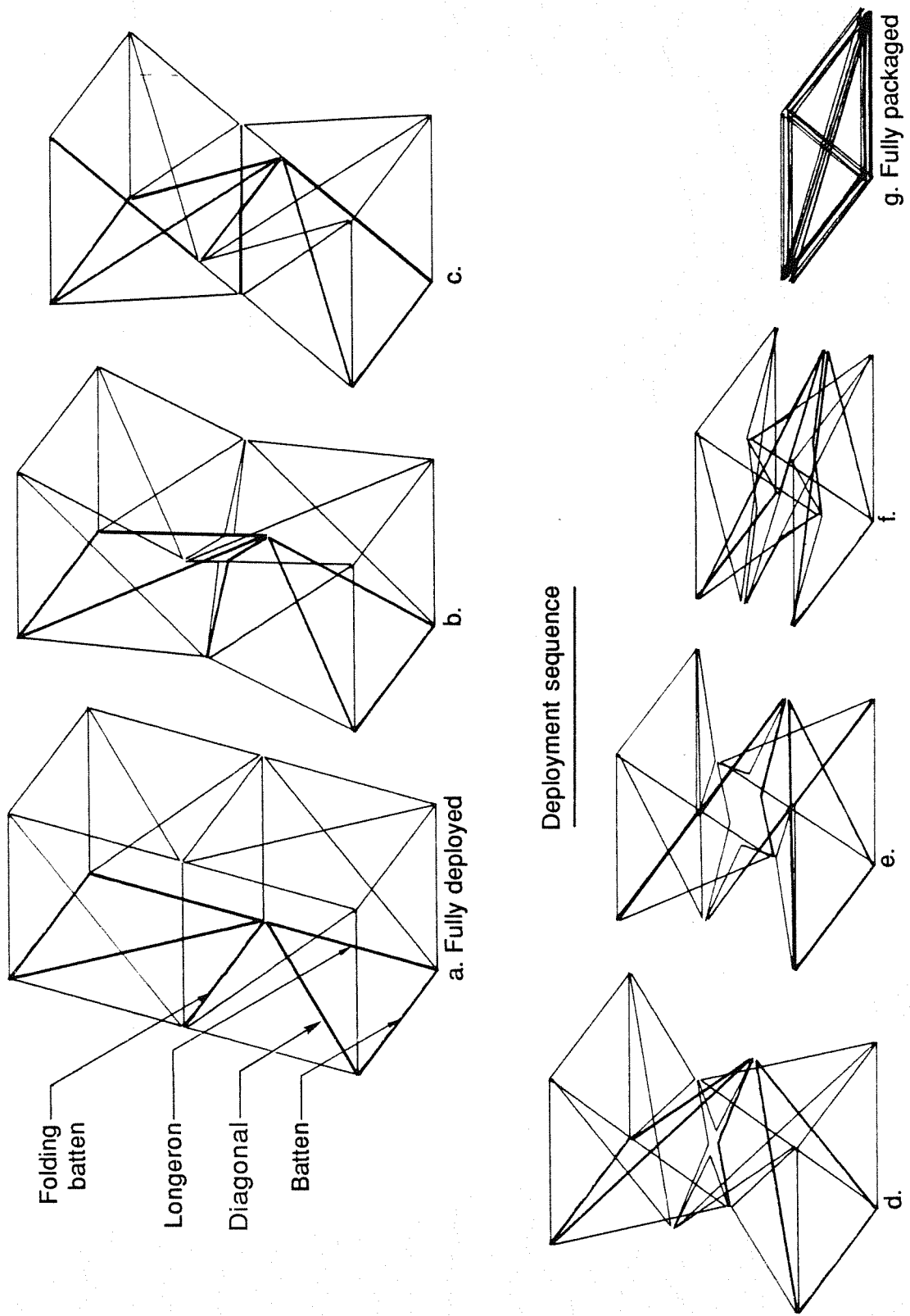
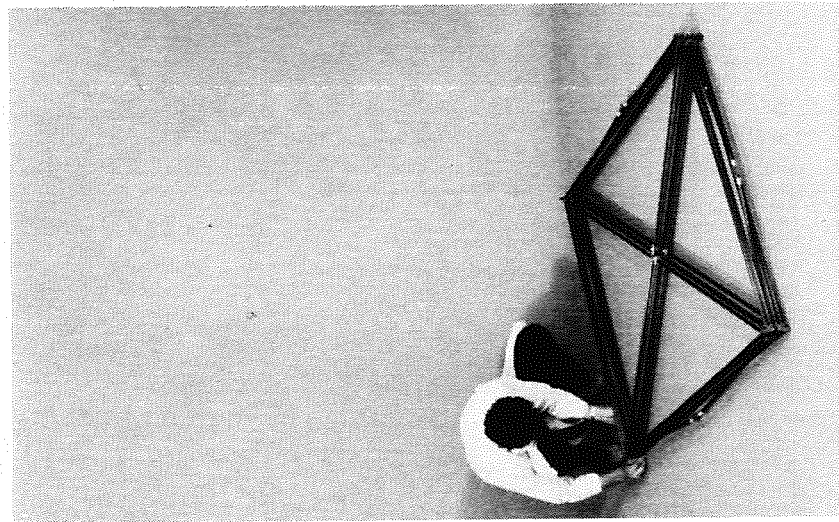
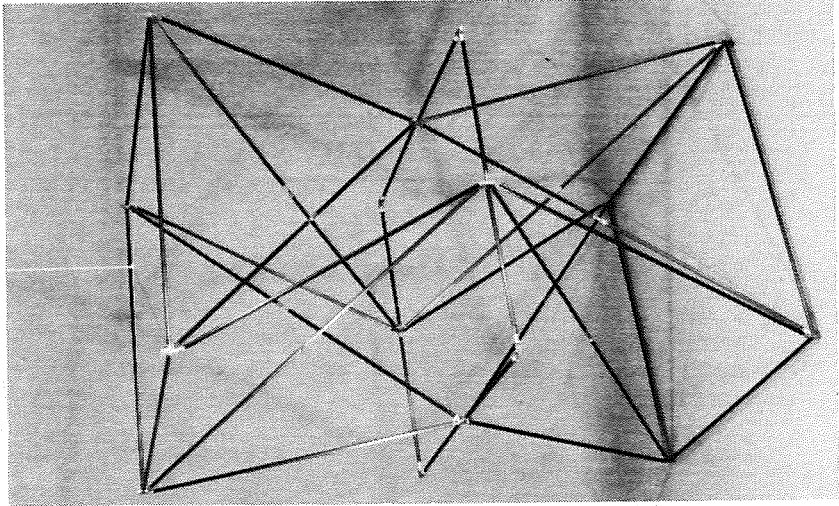

Figure 2. X-Beam concept.



a. Packaged



b. Mid-deployment

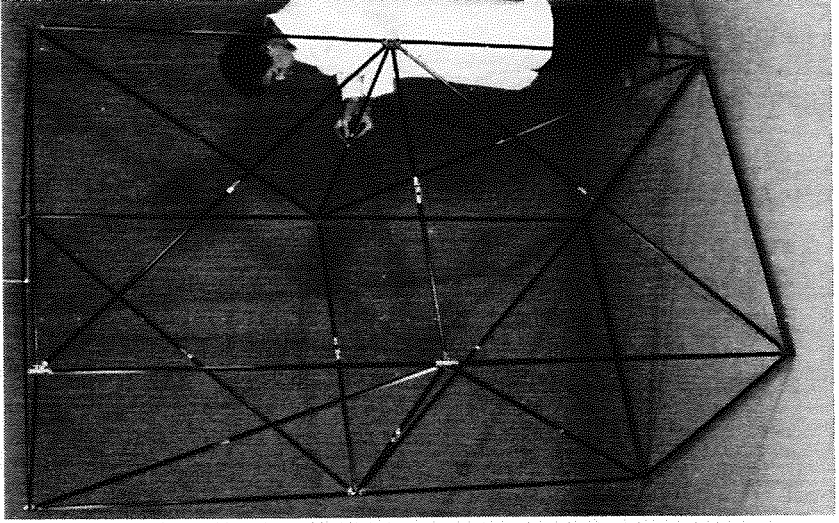

c. Fully deployed

Figure 3. X-Beam prototype model, with outwardly-folding mid battens.

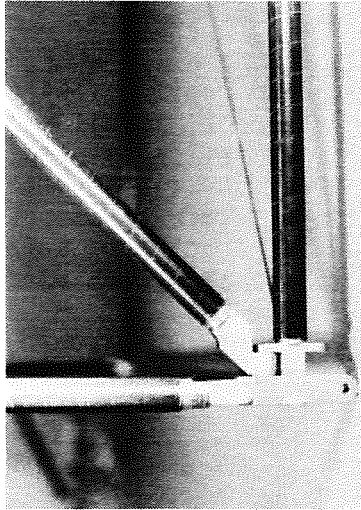
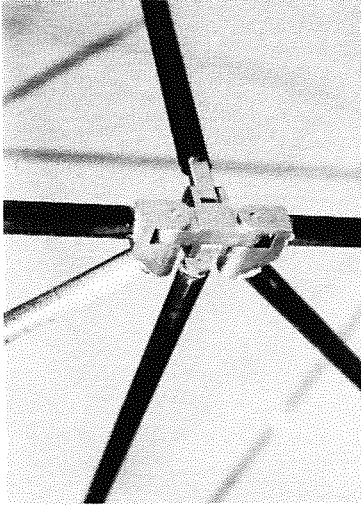
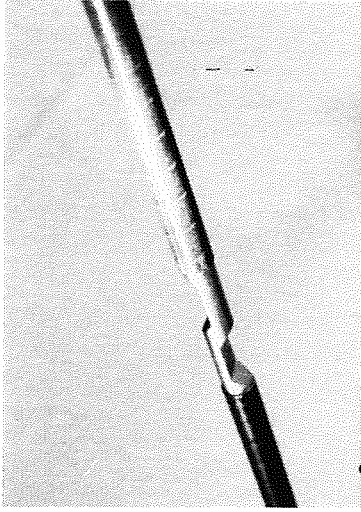

a. Deployed

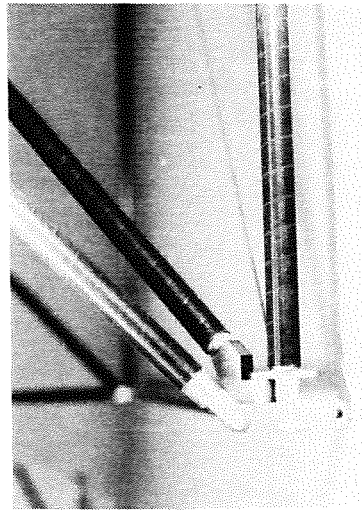

b. Deploying

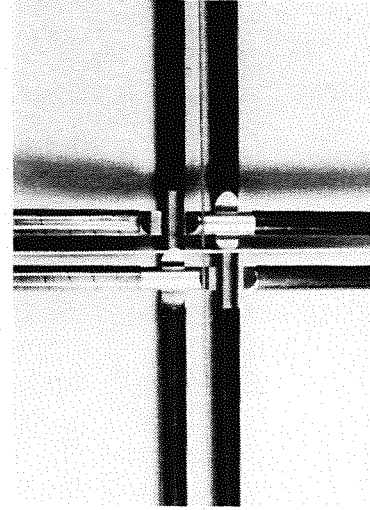

Diagonal cross-overs

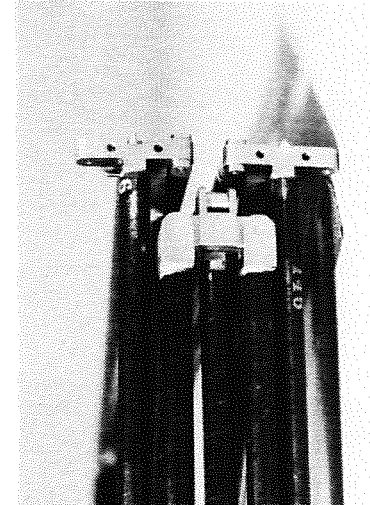

Mid cluster

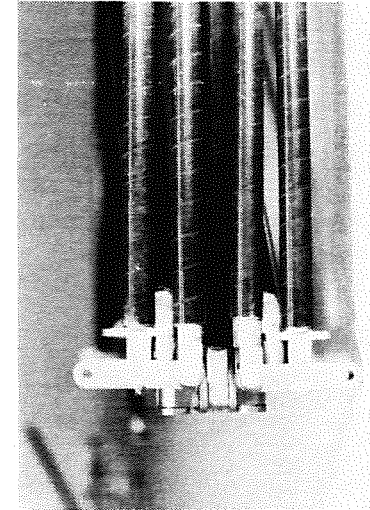

Base hinge cluster

c. Packaged

Figure 4. X-Beam prototype hinge fittings.

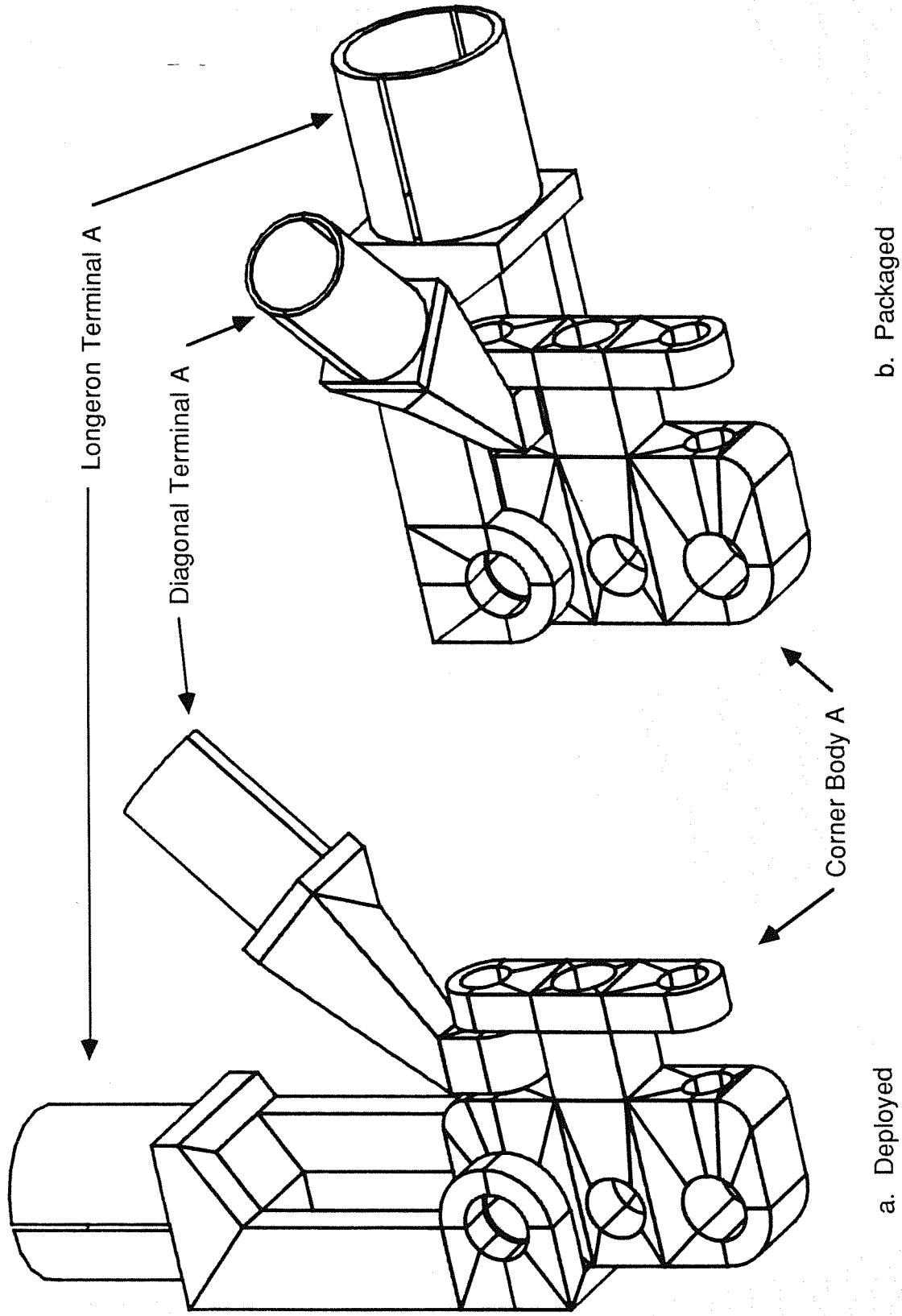

Figure 5. X-Beam Cluster A (at rigid batten).

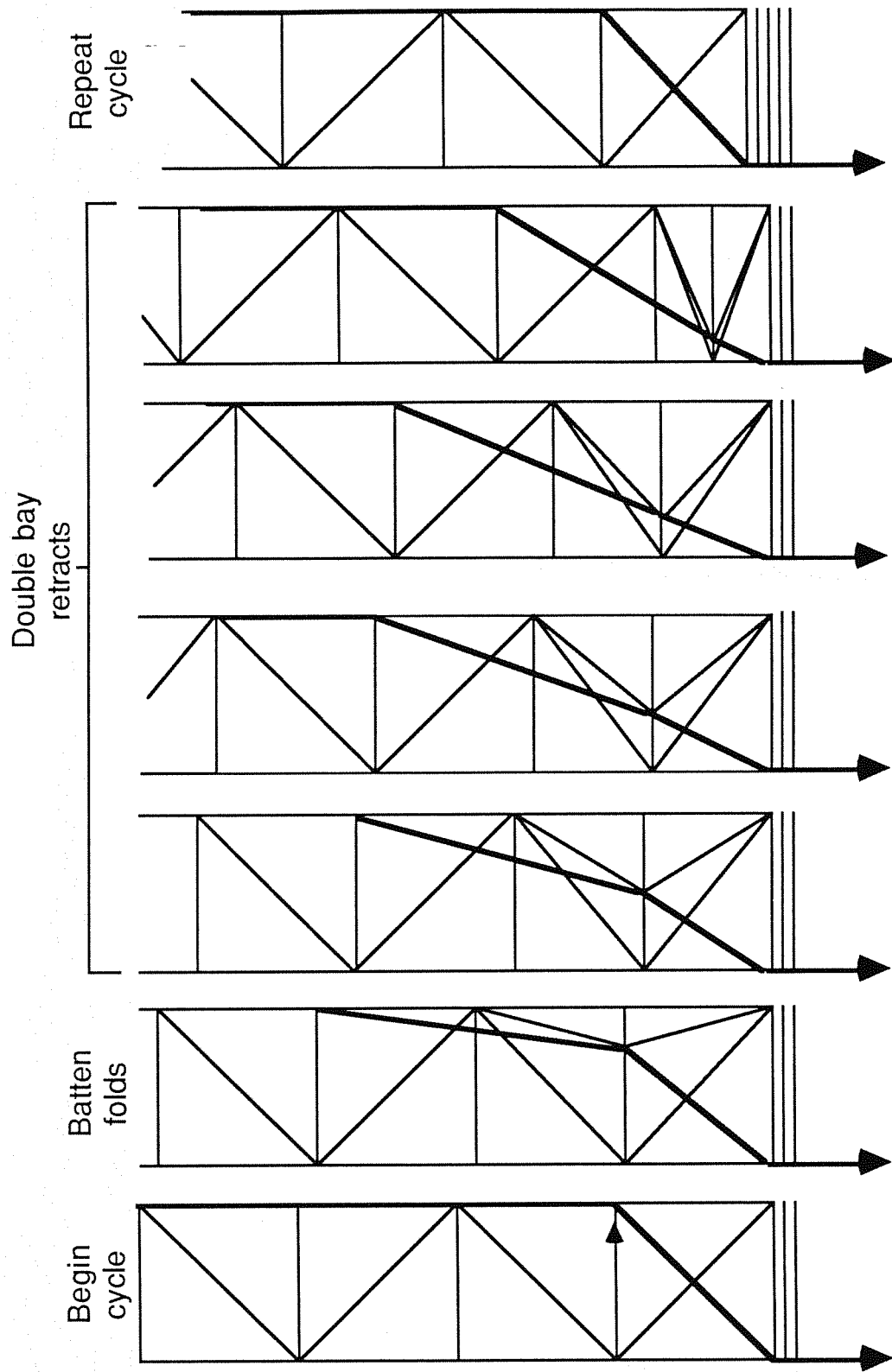

Figure 6. Retraction by ribbon cables.