

Measured Performance Characteristics (Typical Performance at 25°C)

Vd = 28.0 V, Id1 + Id1a = 528 mA, Id2 + Id2a = 2112 mA

Linear Gain vs. Frequency *

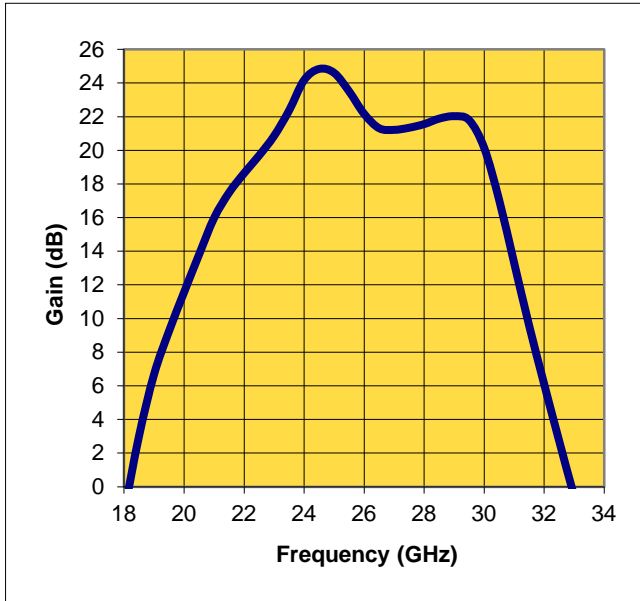

Power, Gain, PAE% vs. Frequency *

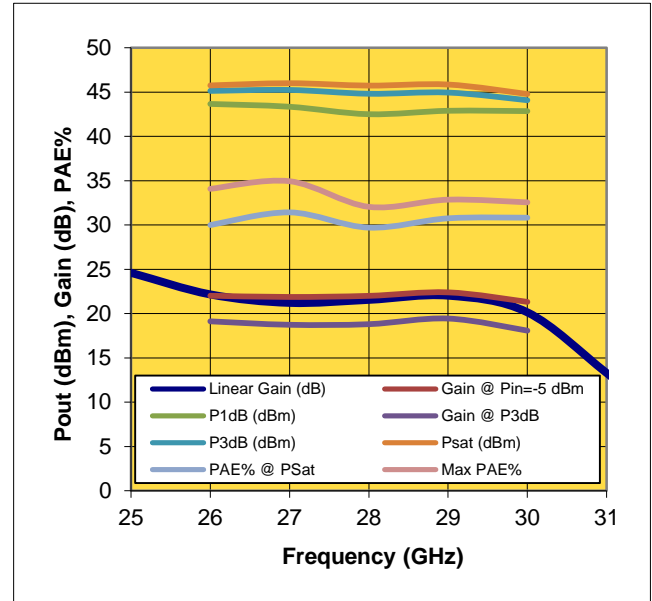

Input Return Loss vs. Frequency *

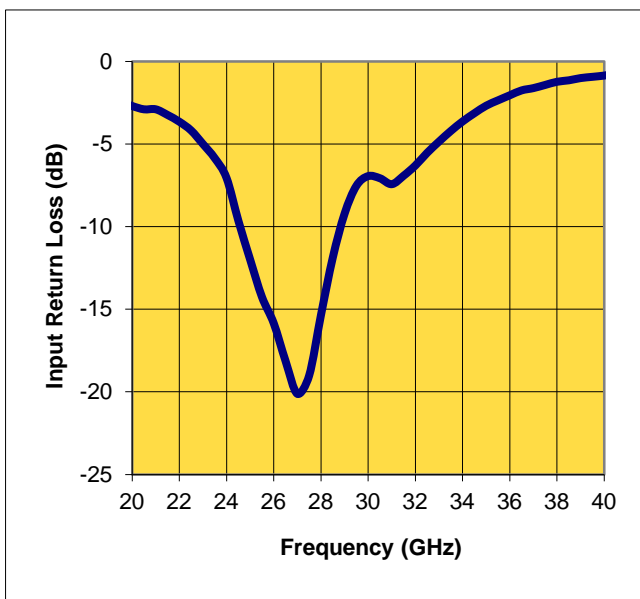

Output Return Loss vs. Frequency *

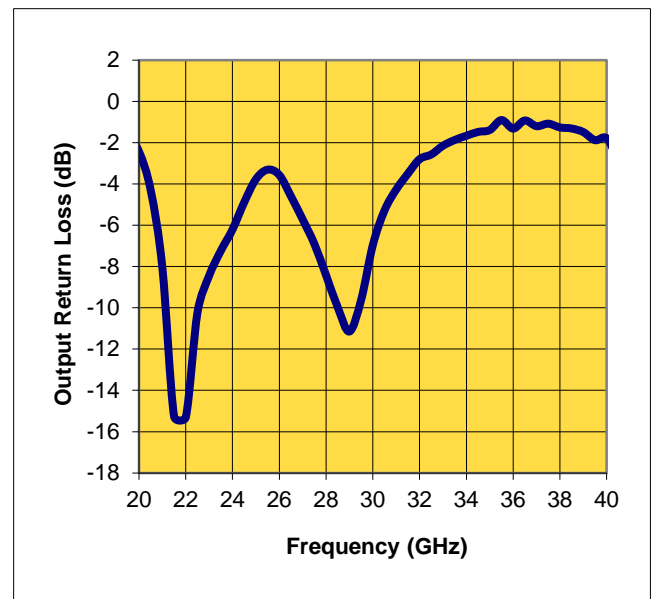

* Pulsed-Power On-Wafer

Preliminary Information: The data contained in this document describes new products in the sampling or preproduction phase of development and is for information only. Northrop Grumman reserves the right to change without notice the characteristic data and other specifications as they apply to this product. The product represented by this datasheet is subject to U.S. Export Law as contained in ITAR or the EAR regulations.

Measured Performance Characteristics (Typical Performance at 25°C)

$V_d = 28.0\text{ V}$, $I_{d1} + I_{d1a} = 528\text{ mA}$, $I_{d2} + I_{d2a} = 2112\text{ mA}$

Power, Gain, PAE% vs. Frequency
Pulsed-Power On-Wafer

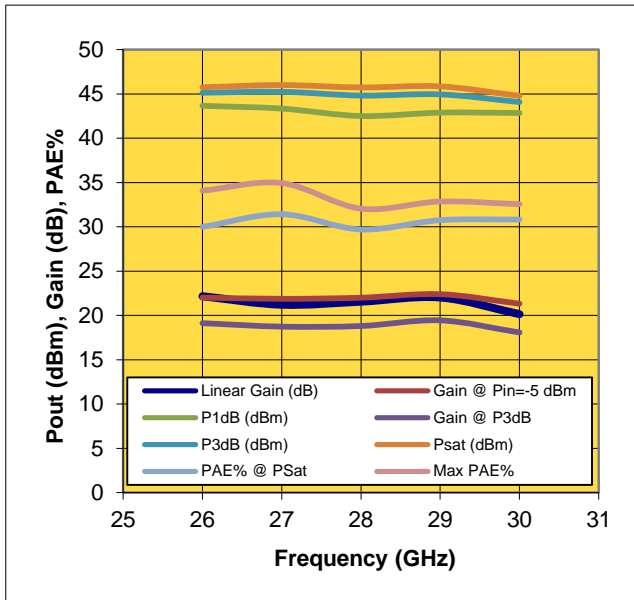

Output Power, Gain vs. Input Power
Pulsed-Power On-Wafer

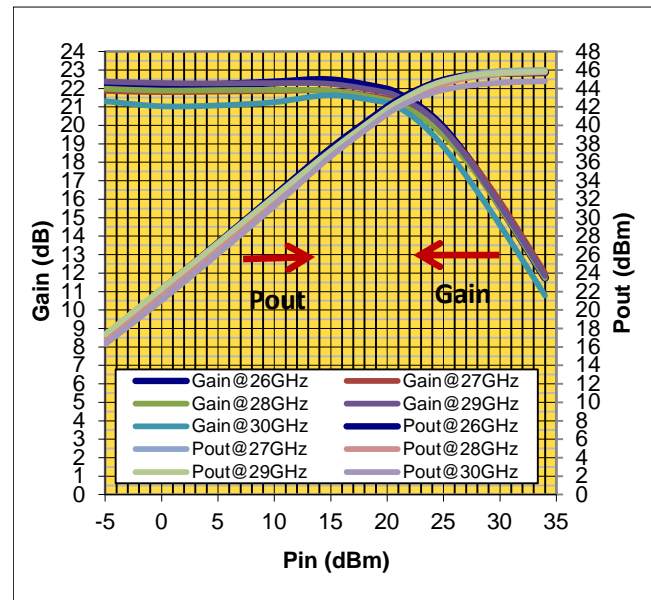

PAE% vs. Input Power
Pulsed-Power On-Wafer

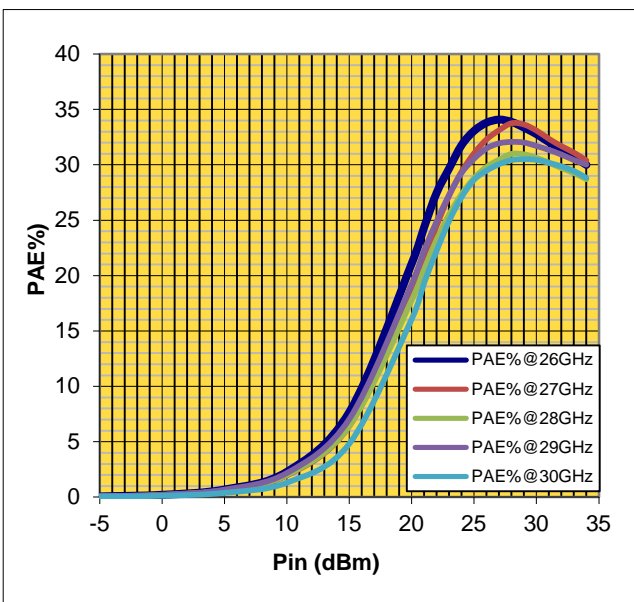

Stage Currents vs. Input Power
Pulsed-Power On-Wafer

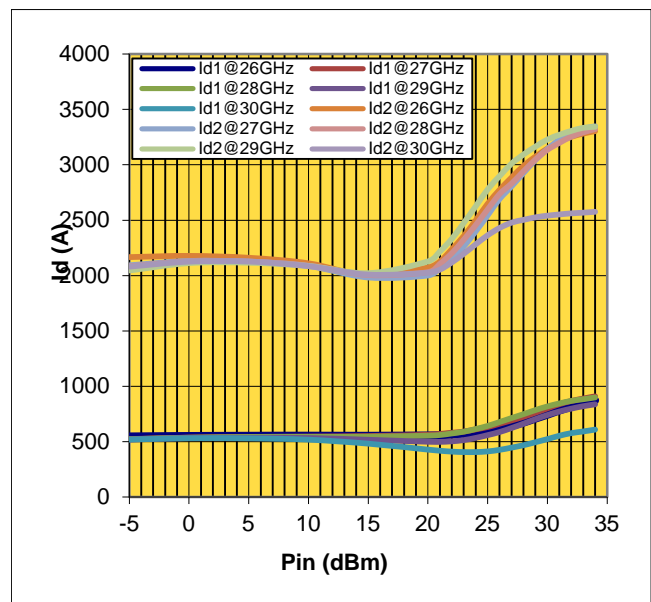

Preliminary Information: The data contained in this document describes new products in the sampling or preproduction phase of development and is for information only. Northrop Grumman reserves the right to change without notice the characteristic data and other specifications as they apply to this product. The product represented by this datasheet is subject to U.S. Export Law as contained in ITAR or the EAR regulations.

APN248

27-30 GHz

GaN Power Amplifier



Advance Datasheet

Revision: May 2015

Measured Performance Characteristics (Typical Performance at 25°C)

$V_d = V_d = 28.0\text{ V}$, $I_{d1} + I_{d1a} = 528\text{ mA}$, $I_{d2} + I_{d2a} = 2112\text{ mA}$

Pout & ACPR vs. Input Power @ 30 GHz
CW in Fixture *

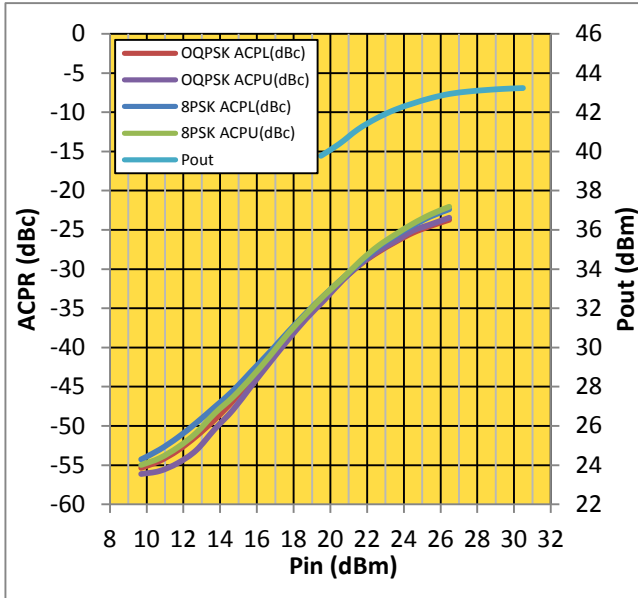

8PSK ACPR -25 dBc @ 30GHz
CW in Fixture *

ACPR vs. Output Power @ 30 GHz
CW in Fixture *

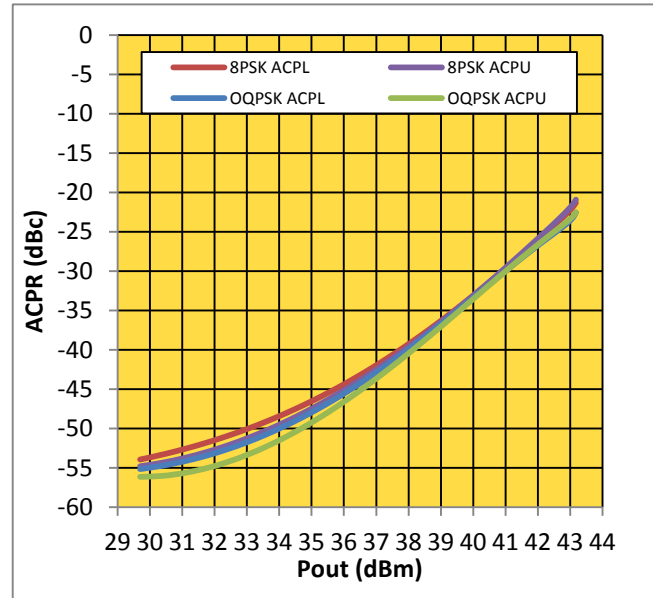

OQPSK ACPR -25 dBc @ 30GHz
CW in Fixture *

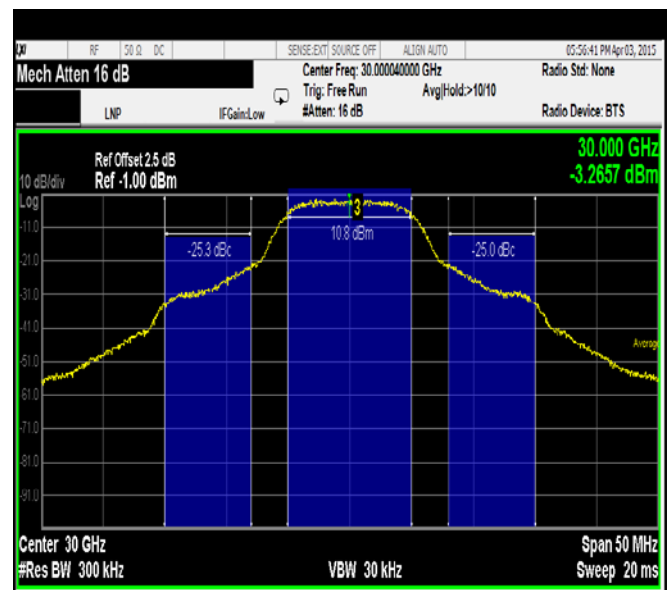
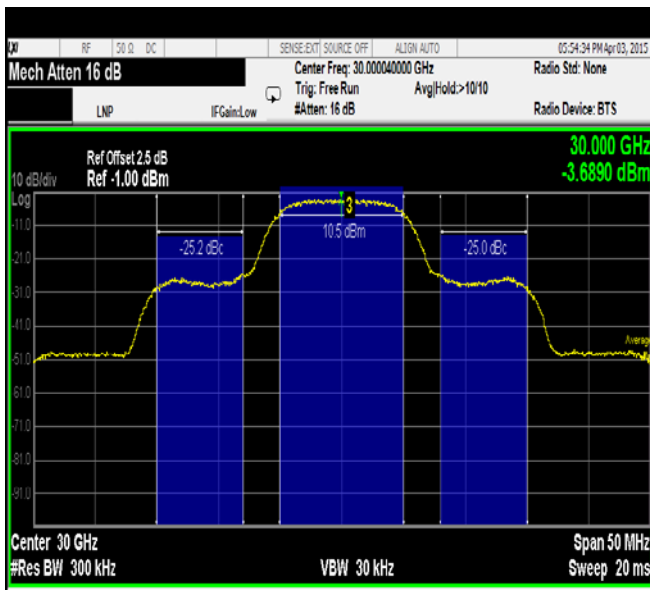

* Parameters Used: Channel BW = 10 MHz, Frequency Offset = 11.5 MHz, Integrated BW = 7 MHz. Uncorrected – includes End-block losses

Preliminary Information: The data contained in this document describes new products in the sampling or preproduction phase of development and is for information only. Northrop Grumman reserves the right to change without notice the characteristic data and other specifications as they apply to this product. The product represented by this datasheet is subject to U.S. Export Law as contained in ITAR or the EAR regulations.

Web: <http://www.as.northropgrumman.com/mps>

©2015 Northrop Grumman Systems Corporation

Phone: (310) 814-5000 • Fax: (310) 812-7011 • E-mail: as-mps.sales@ngc.com

APN248

27-30 GHz

GaN Power Amplifier



Advance Datasheet

Revision: May 2015

Measured Performance Characteristics (Typical Performance at 25°C)

Vd = 28.0 V, Id1 + Id1a = 528 mA, Id2 + Id2a = 2112 mA

8PSK ACPR -30 dBc @ 30GHz
CW in Fixture *

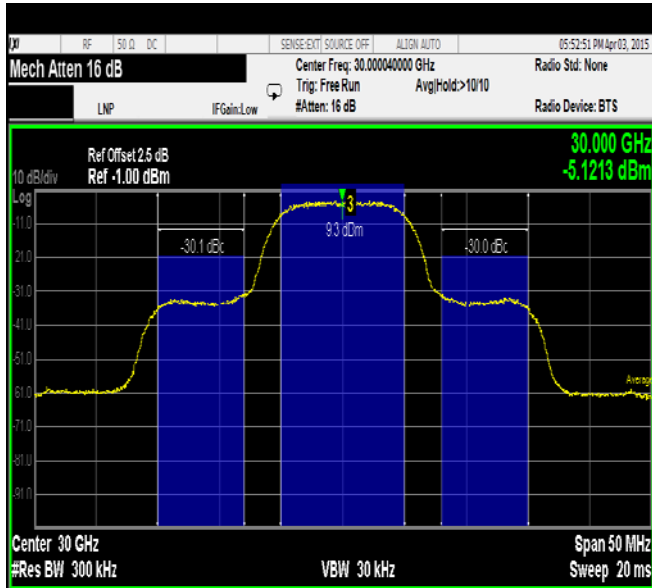

OQPSK ACPR -30 dBc @ 30GHz
CW in Fixture *

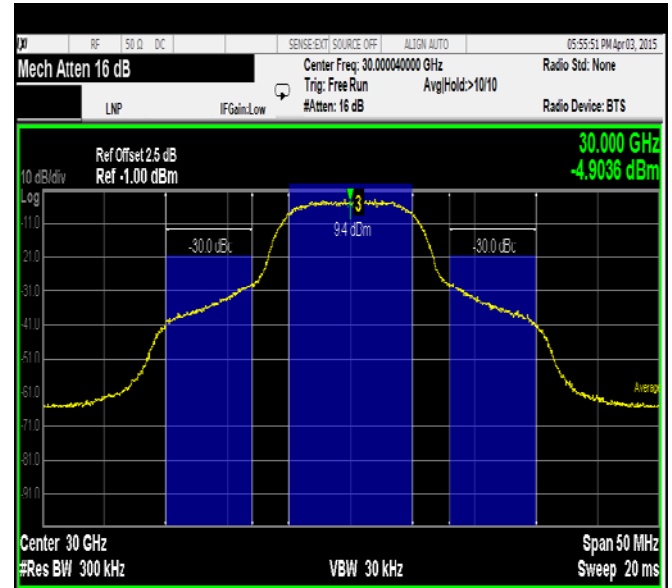

* Parameters Used: Channel BW = 10 MHz, Frequency Offset = 11.5 MHz, Integrated BW = 7 MHz. Uncorrected – includes End-block losses

Preliminary Information: The data contained in this document describes new products in the sampling or preproduction phase of development and is for information only. Northrop Grumman reserves the right to change without notice the characteristic data and other specifications as they apply to this product. The product represented by this datasheet is subject to U.S. Export Law as contained in ITAR or the EAR regulations.

Web: <http://www.as.northropgrumman.com/mps>

©2015 Northrop Grumman Systems Corporation

Phone: (310) 814-5000 • Fax: (310) 812-7011 • E-mail: as-mps.sales@ngc.com

Page 5

APN248

27-30 GHz

GaN Power Amplifier



Advance Datasheet

Revision: May 2015

Die Size and Bond Pad Locations (Not to Scale)

X = 3300 μm \pm 25 μm

Y = 4100 μm \pm 25 μm

DC Bond Pad = 100 x 100 \pm 0.5 μm

RF Bond Pad = 100 x 100 \pm 0.5 μm

Chip Thickness = 101 \pm 5 μm

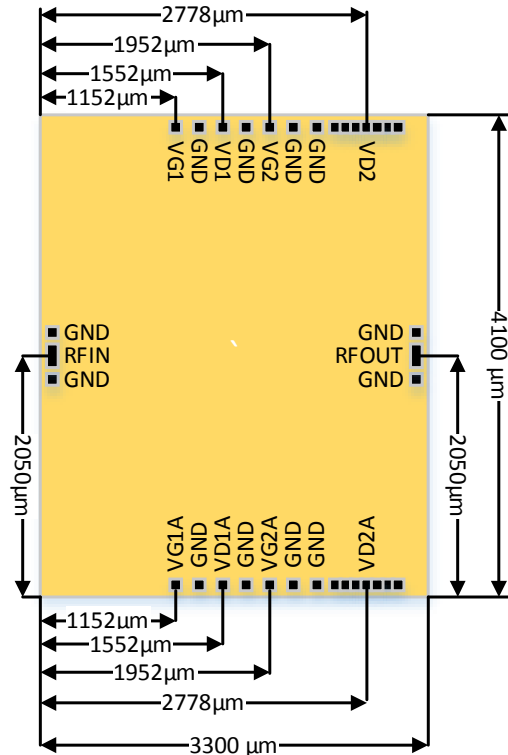

Biasing/De-Biasing Details:

Bias for 1st stage is from top. The 2nd stages must bias up from both sides.

Listed below are some guidelines for GaN device testing and wire bonding:

- a. Limit positive gate bias (G-S or G-D) to < 1V
- b. Know your devices' breakdown voltages
- c. Use a power supply with both voltage and current limit.
- d. With the power supply off and the voltage and current levels at minimum, attach the ground lead to your test fixture.
 - i. Apply negative gate voltage (-5 V) to ensure that all devices are off
 - ii. Ramp up drain bias to ~10 V
 - iii. Gradually increase gate bias voltage while monitoring drain current until 20% of the operating current is achieved
 - iv. Ramp up drain to operating bias
 - v. Gradually increase gate bias voltage while monitoring drain current until the operating current is achieved
- e. To safely de-bias GaN devices, start by debiasing output amplifier stages first (if applicable):
 - i. Gradually decrease drain bias to 0 V.
 - ii. Gradually decrease gate bias to 0 V.
 - iii. Turn off supply voltages
- f. Repeat de-bias procedure for each amplifier stage

Preliminary Information: The data contained in this document describes new products in the sampling or preproduction phase of development and is for information only. Northrop Grumman reserves the right to change without notice the characteristic data and other specifications as they apply to this product. The product represented by this datasheet is subject to U.S. Export Law as contained in ITAR or the EAR regulations.

Web: <http://www.as.northropgrumman.com/mps>

©2015 Northrop Grumman Systems Corporation

Phone: (310) 814-5000 • Fax: (310) 812-7011 • E-mail: as-mps.sales@ngc.com

APN248

27-30 GHz

GaN Power Amplifier



Advance Datasheet
Suggested Bonding Arrangement

Revision: May 2015

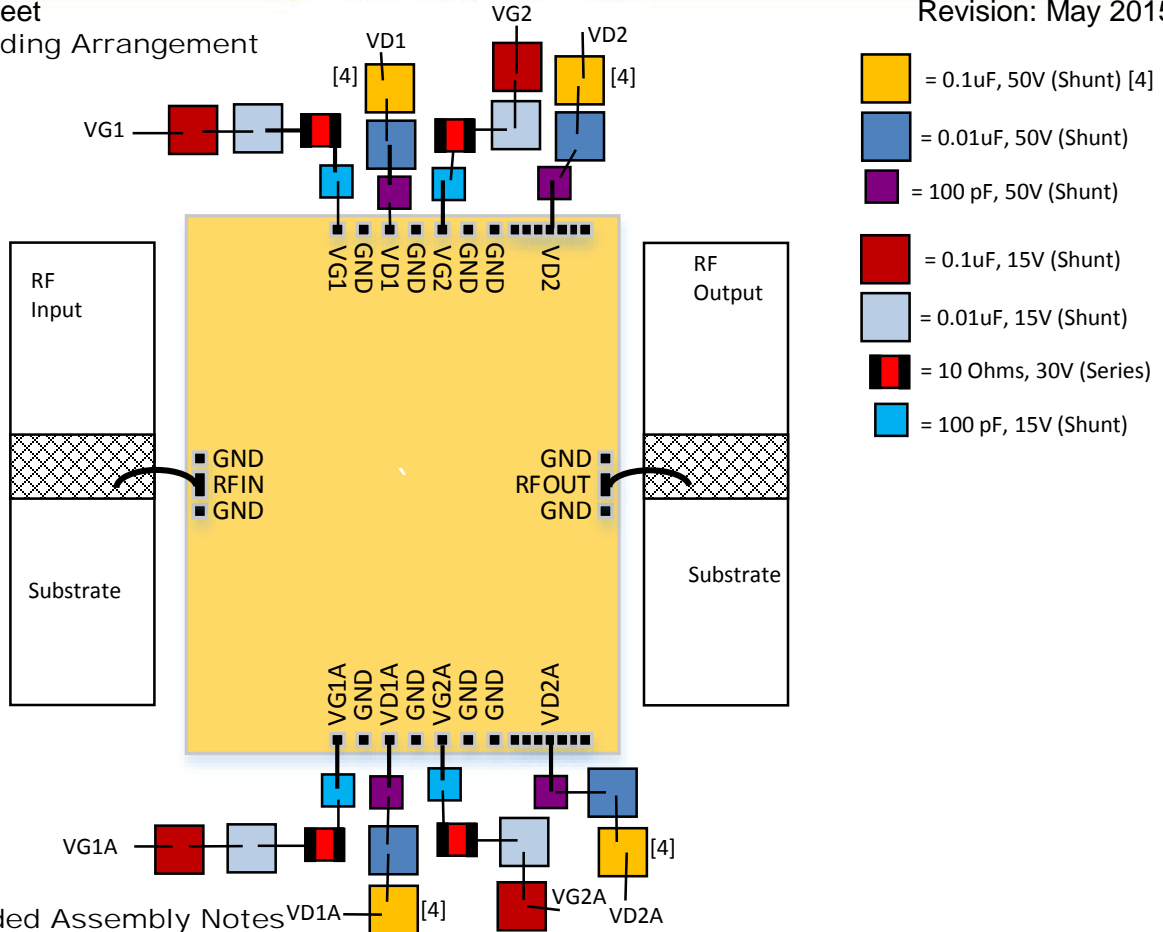

Recommended Assembly Notes

1. Bypass caps should be 100 pF (approximately) ceramic (single-layer) placed no farther than 30 mils from the amplifier.
2. Best performance obtained from use of <10 mil (long) by 3 by 0.5 mil ribbons on input and output.
3. Part must be biased from both sides as indicated.
4. The 0.1uF, 50V capacitors are not needed if the drain supply line is clean. If Drain Pulsing of the device is to be used, do **NOT** use the 0.1uF, 50V Capacitors.

Mounting Processes

Most NGAS GaN IC chips have a gold backing and can be mounted successfully using either a conductive epoxy or AuSn attachment. NGAS recommends the use of AuSn for high power devices to provide a good thermal path and a good RF path to ground. Maximum recommended temp during die attach is 320°C for 30 seconds.

Note: Many of the NGAS parts do incorporate airbridges, so caution should be used when determining the pick up tool.

CAUTION: THE IMPROPER USE OF AuSn ATTACHMENT CAN CATASTROPHICALLY DAMAGE GaN CHIPS. PLEASE ALSO REFER TO OUR "GaN Chip Handling Application Note" BEFORE HANDLING, ASSEMBLING OR BIASING THESE MMICS!

Preliminary Information: The data contained in this document describes new products in the sampling or preproduction phase of development and is for information only. Northrop Grumman reserves the right to change without notice the characteristic data and other specifications as they apply to this product. The product represented by this datasheet is subject to U.S. Export Law as contained in ITAR or the EAR regulations.

Web: <http://www.as.northropgrumman.com/mps>

©2015 Northrop Grumman Systems Corporation

Phone: (310) 814-5000 • Fax: (310) 812-7011 • E-mail: as-mps.sales@ngc.com

Page 7